

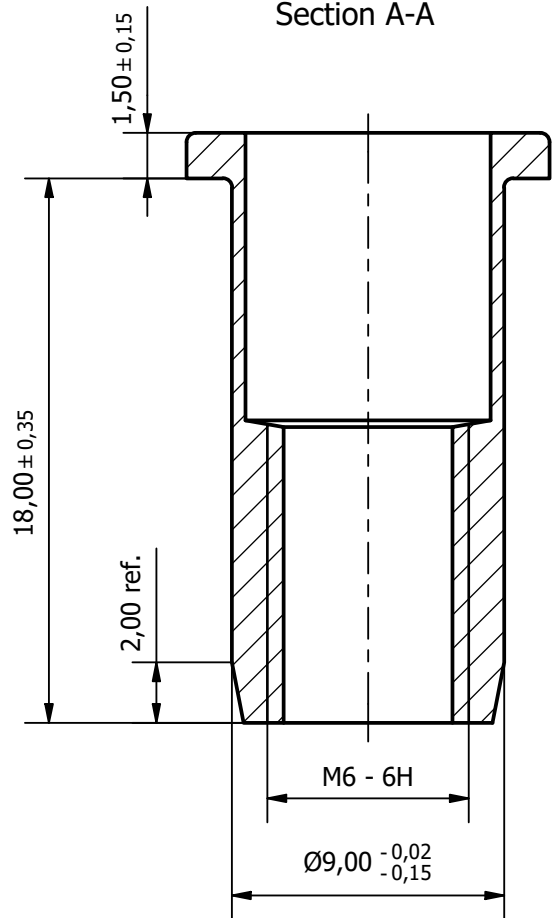

This drawing is property of Dejongd. No reproduction without written permission!

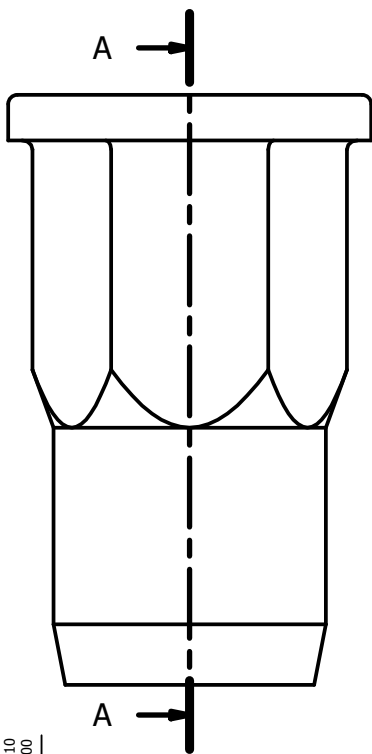

Hole size

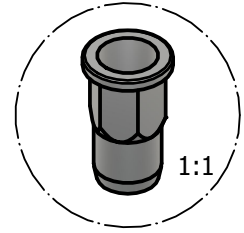
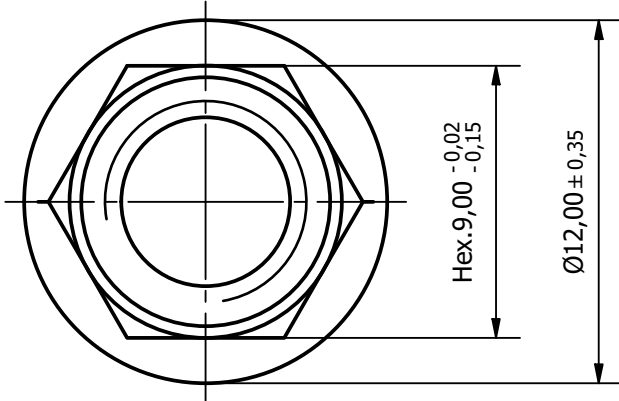
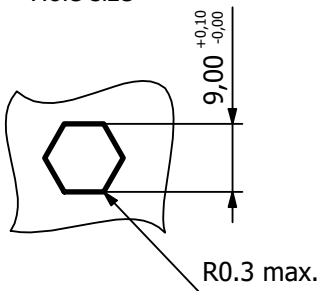

GRIP 3,0 - 5,0 mm

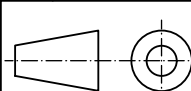
REV	DESCRIPTION			STATUS	APPROVED	DATE
B	changed length and changed inner geometry			Released	Michiel	4/02/2026
Finish / Coating : Polished				 Tubtara [®] BLIND RIVET NUTS <small>A BRAND BY DEJOND NV</small>		
	Name	Date	Material : Stainless steel 254 SMO			
Designed by	simon	4/02/2026	Sp. Treat. :	Art. Nr. : 546918		
A4		Scale 4 : 1	Art. Nr. Cust. :	Draw. Nr. : 254 SMO M6 HUPO 050523 DR		
			Weight : ± 4,9 g			