



R4-EM 9 Series Electromechanical Rotary Lock

Concealed cam

Electronic access with internal motor control

- Push-to-close, electronic release
- High electromechanical release load
- Minimal power draw
- Integrated connector
- Extended housing option for added security
- Door and Trigger Sensor
- Microswitch to detect latch status
- Mechanical over-ride with integrated cable bracket
- 12V to 24V operations
- Efficient DC gear motor actuation
- Detent mechanism for pull-open function
- Simple two-hole installation



12V

24V

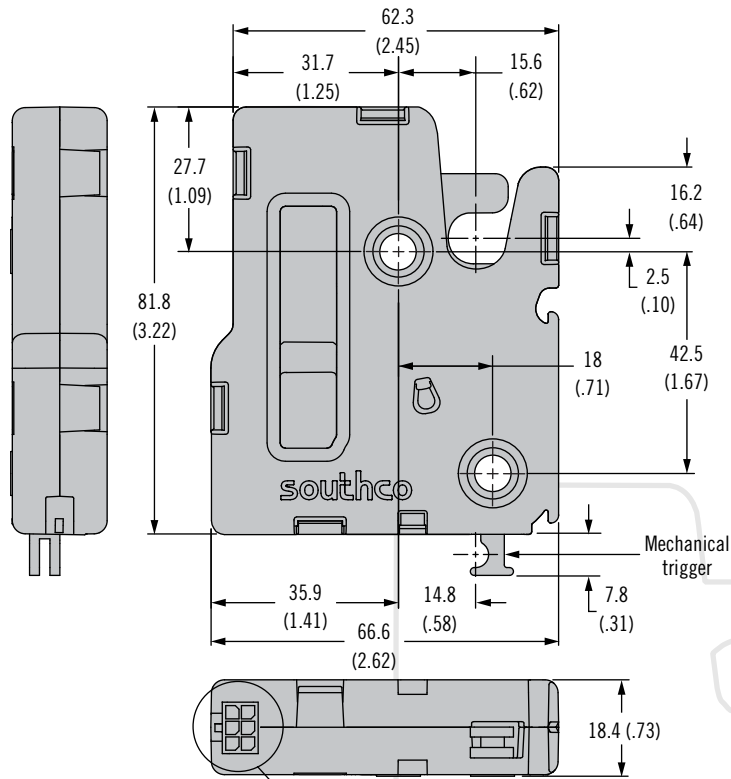
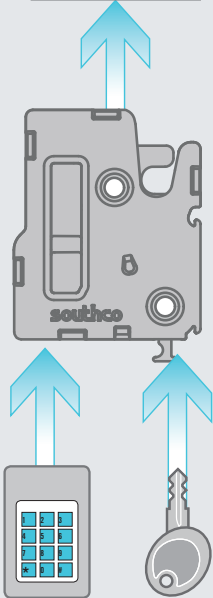

Latch Wiring Connections

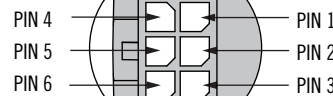

ACTUAL SIZE

Part Number Selection

R4 - EM - 9 T B - 150 - P

T Trigger Styles

- A** Auto relock, rear trigger, with kick-out spring
- D** Delayed relock, rear trigger, with kick-out spring
- P** Delayed relock, rear trigger, pull to open

B Base Mounting Style

- 1** 1/4 - 20 thread
- 2** M6 thread
- 3** Ø 7.0 (.27) thru hole

- P Packaging Options**
- None** Individually packaged
 - 1** Bulk packaged

Other options available. For complete details on variety, part numbers, installation and specification, go to



www.southco.com/R4-EM

Dimensions in millimeters (inch) unless otherwise stated



Installation

Panel Preparation

Base Mounting Style	Recommended minimum mounting hole
1/4-20 thread	Ø 7.2 (.283)
M6 thread	Ø 6.9 (.272)
Thru hole	Ø 7.6 (.300)

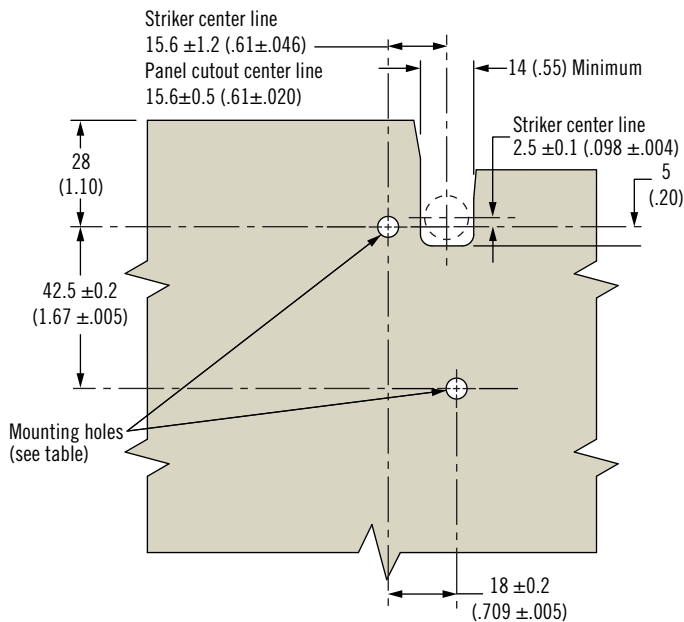

Operation

See page 34 for operating instructions

Accessories

Striker Bolt or Cast Striker

See page 35

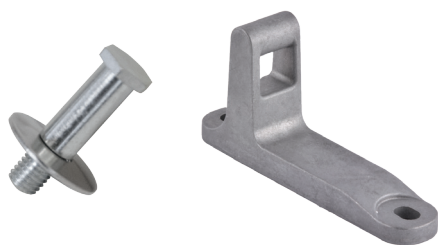

Cable Mounting Kit

See page 35



Material & Finish

Top and Bottom housings:

PC/ABS

Pivot Pins: Steel, zinc plated

Cam, Trigger: Steel, sealed

Springs: Stainless steel passivated

Trigger Interlock Lever: Glass-filled nylon

Bistable Spring Retainer: Zinc Alloy

Drive Cam: Acetal, black

Output Cam: Acetal, white

Electrical Specifications

Recommended Operating Voltage:

12 to 24 VDC

Typical Operating Current :

12 V Models: Less than 500mA

Latch Connector

Pin Assignment

PIN 1: Ground (-)

PIN 2: Power (+)

PIN 3: Control Signal

PIN 4: Latch Status

PIN 5: None

PIN 6: Door status

Electronic Actuators

See page 42



Mechanical Actuators

See page 36



Cables

See page 272



Wiring/Junctions

See www.southco.com



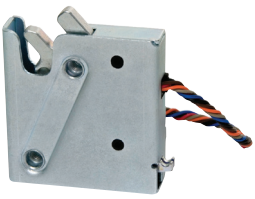

R4-EM Electronic Rotary Latch

Operating instructions

Operation - Auto relock

1. The signal unlocks the R4-EM latch and releases the spring loaded cam which rotates out to push a lightweight door open. The mechanism will cycle through unlatched then re-latched state automatically, regardless of input signal on time.
2. Push door closed to engage striker after unlock time has expired. Striker will rotate cam to closed position.

Operation - Delayed relock

1. The signal unlocks the R4-EM latch leaving a biased closed door in the closed position. The unlock time is controlled by the access control device.
2. Manually pull door/striker free from R4-EM latch.
3. Manually push door closed. Striker will rotate cam to closed position, however latch will remain unlocked and can be re-opened as long as signal is present.
4. After accessing the door, the signal can be removed to re-lock the R4-EM. This can be done with the door in the open or closed position.

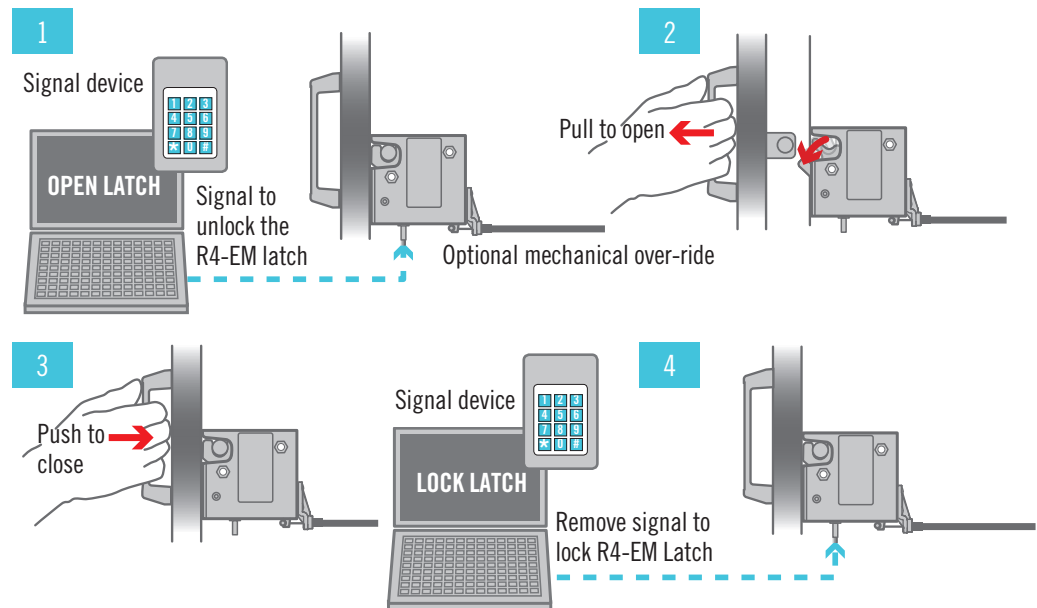
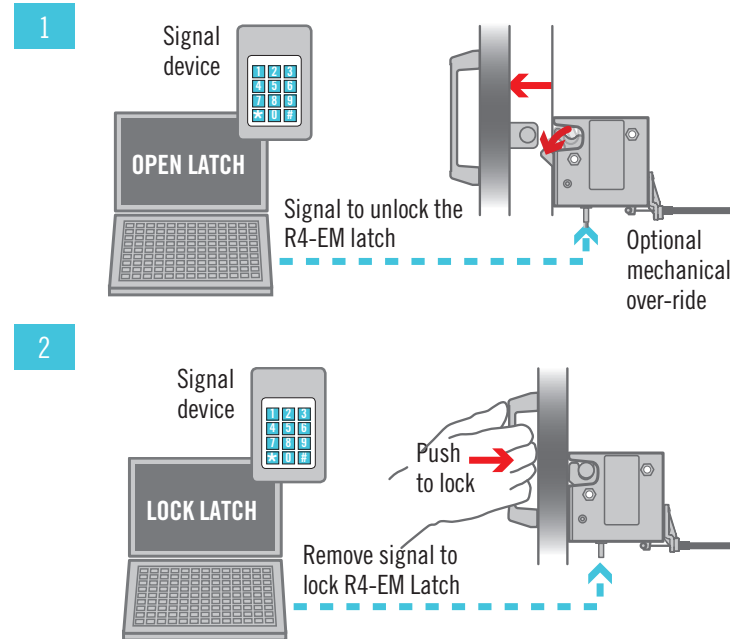

Other options available. For complete details on variety, part numbers, installation and specification, go to



www.southco.com/R4-EM

Dimensions in millimeters (inch) unless otherwise stated

southco
CONNECT · CREATE · INNOVATE

R4-EM Electronic Rotary Latch

Strikers - Cable mounting kits



Striker Bolt - Large

Part number R4-90-121-10

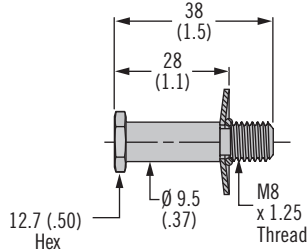

Striker Bolt - Small

Part number R4-90-511-10

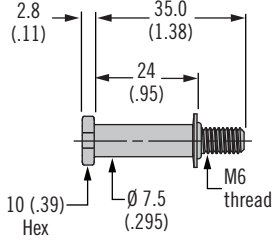

Cast Striker with Door Sensor Part number R4-90-804-10*

Cast Striker without Door Sensor Part number R4-90-800-10*

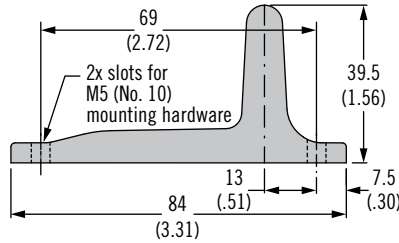
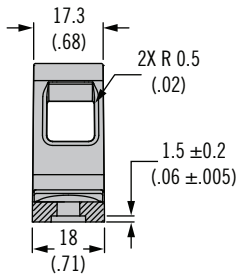





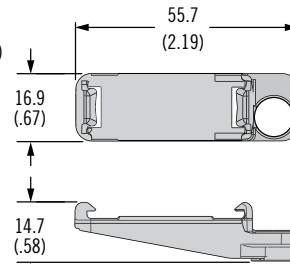
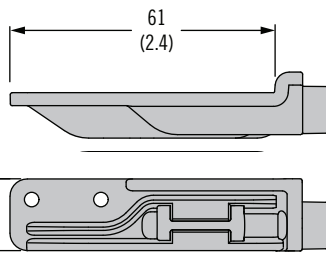
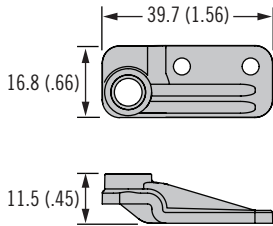

Cable Mounting Kit

Part number R4-EM-52 – Rivets included
Part number R4-EM-72 – Screws included

Part number R4-EM-87 – Rivets included

Part number R4-EM-952



	Striker Bolt		Cast Striker		Cable Mounting Kit			
	R4-90-121-10	R4-90-511-10	R4-90-800-10	R4-90-804-10	R4-EM-52	R4-EM-72	R4-EM-87	R4-EM-952
 R4-EM-9	✓		✓	✓				✓
 R4-EM-8	✓		✓	✓				
 R4-EM-5 & 7	✓		✓		✓		✓	
 R4-EM-4 & 6		✓				✓		
 R4-EM-1 & 2	✓		✓		✓		✓	

Material and Finish

Striker bolts: Steel, zinc plated
Cast strikers: Zinc alloy
Cable mounting kits: Glass-filled nylon, black

*Note: Latch and striker installation details can be found on the latch trade drawing at www.southco.com.