



01 Cam Latch

Small · Flush handle · Cup style · Adjustable grip

• **Low profile design**

Material and Finish

ABS, zinc and steel, zinc plated

Performance Details

Max. static load: 160 N (35 lbf)

Flammability rating: UL94-HB

Notes

For multi-point latching options see pages 244 - 245

For fixed grip version see pages 90 - 91

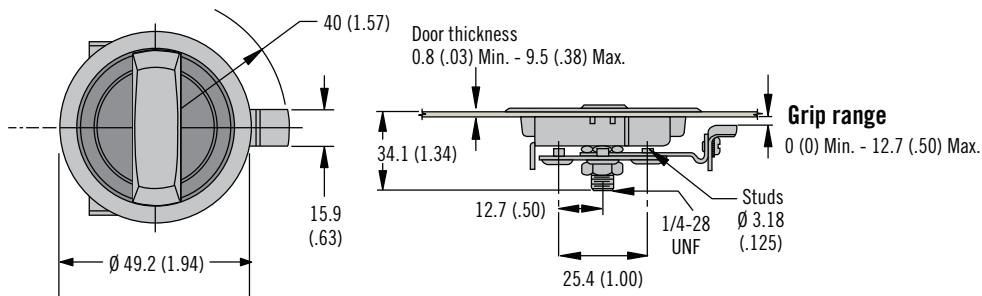

Type A (shown)

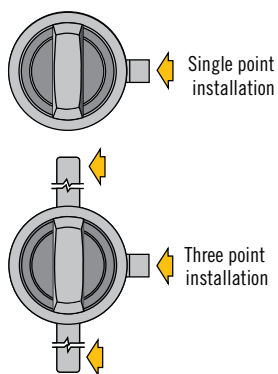
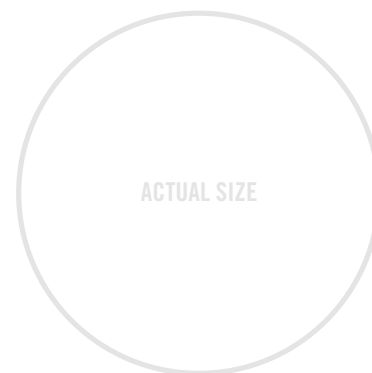
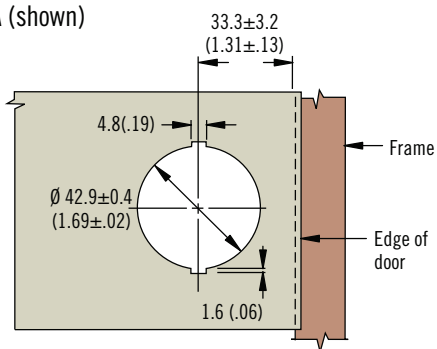

Type A Assemblies (Turn handle clockwise to latch)

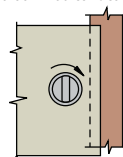

Handle shown **parallel** to edge of door when latched

Type B Assemblies (Turn handle counter-clockwise to latch)

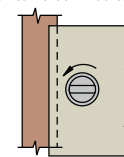

Handle shown **perpendicular** to edge of door when latched

• Mounted on either type A or B doors.

Choose horizontal or vertical closed position of handle

Part Number Selection

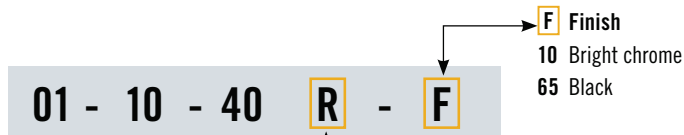

R Rotation

- 1 Type B counter-clockwise to latch for parallel installation
- 2 Type B counter-clockwise to latch for perpendicular installation
- 1 Type A clockwise to latch for perpendicular installation
- 2 Type A clockwise to latch for parallel installation

Dimensions in millimeters (inch) unless otherwise stated