

UL94 V-2 NYLON 6/6, RMS-01 COLOUR: NATURAL	UL94 V-0 NYLON 6/6, RMS-19 COLOUR: NATURAL	"A" REF	"B" REF	"C" REF	"D" REF	FIGURE
OFNS-13-187-01	OFNS-13-187-19	26.8[1.06]	21.2[.83]	19[.75]	28.2[1.11]	1
OFNS-13-312-01	OFNS-13-312-19					2
OFNS-13-250-01	OFNS-13-250-19					4
OFNS-13-S307-01	OFNS-13-S307-19					3
OFNS-13-S9.5M-01	OFNS-13-S9.5M-19					5
OFNSB-13-01A2-RT	OFNSB-13-19A2-RT					6
OFNS-16-187-01	OFNS-16-187-19	34.3[1.35]	28.7[1.13]	25.1[.99]	34.4[1.35]	1
OFNS-16-312-01	OFNS-16-312-19					2
OFNS-16-S307-01	OFNS-16-S307-19					3
OFNS-16-S9.5M-01	OFNS-16-S9.5M-19					5
OFNSB-16-01A2-RT	OFNSB-16-19A2-RT					6
OFNS-28-S9.5M-01	OFNS-28-S9.5M-19					43[1.69]

AVAILABLE IN BLACK COLOUR BY SPECIAL ORDER. TO ORDER, ADD "BK" TO THE END OF THE PART NUMBER

REV.	MODIFICATION.	DATE	DRN
01	Production release	04/09/09	MT
02	CO2010839	19/10/09	MT
03	CO2010917	12/5/10	TC
04	CO2011008	14/10/10	SF

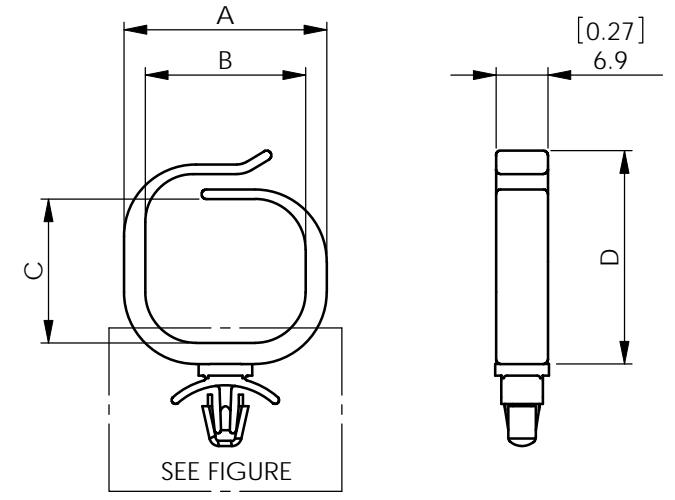

ALTERNATE UNITS FOR REFERENCE ONLY

INFORMATION CONTAINED IN THIS DOCUMENT IS CONFIDENTIAL TO RICHCO INTERNATIONAL Co. Ltd. AND MAY NOT BE DISCLOSED OR REPRODUCED IN WHOLE OR PART WITHOUT THEIR WRITTEN CONSENT.

RICHCO, INC. WWW.RICHCO-INC.COM	ALL DIMENSIONS IN mm GENERAL TOLERANCES ±0.25 UNLESS OTHERWISE STATED 1 DECIMAL PLACE ± 2 DECIMAL PLACES ± ANGULAR ±1°	THIRD ANGLE
	MATERIAL: SEE TABLE COLOUR: SEE TABLE	

DESCRIPTION: OPTICAL FIBER NETWORK SADDLE PART No: SEE TABLE

DRG No: 09-089 PROJECT NUMBER: SHEET SIZE A4

DRN	DATE	CHKD	DATE	SCALE	SHEET No.
MT	04/09/09	TC	04/09/09	NTS	1 OF 1

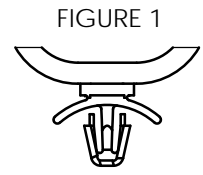

FIGURE 1
TO SNAP LOCK INTO A
Ø4.75±0.08[.187±.003] HOLE
IN A 0.8-2.0[.031-.079]
THICK PANEL

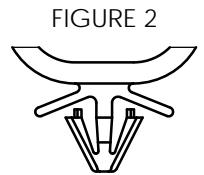

FIGURE 2
TO SNAP LOCK INTO A
Ø7.92±0.08[.312±.003] HOLE
IN A 0.8-1.6[.031-.063]
THICK PANEL

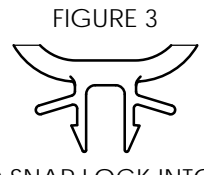

FIGURE 3
TO SNAP LOCK INTO A
7.80±0.08[.307±.003] SQUARE HOLE
IN A 0.8-2.0[.031-.079]
THICK PANEL

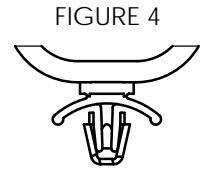

FIGURE 4
TO SNAP LOCK INTO A
Ø6.35±0.08[.250±.003] HOLE
IN A 0.8-2.0[.031-.079]
THICK PANEL

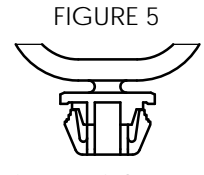

FIGURE 5
TO SNAP LOCK INTO A
9.50±0.08[.374±.003] SQUARE HOLE
IN A 0.8-2.0[.031-.079]
THICK PANEL

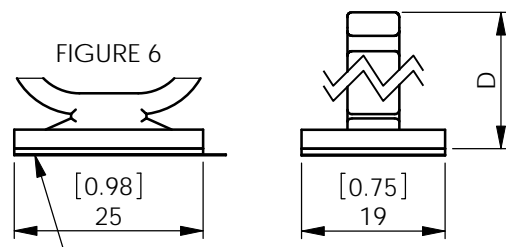

FIGURE 6
0.8[.03] THICK DOUBLE SIDED
ADHESIVE TAPE WITH RELEASE
TAB, RMS-24