

Double knuckle continuous hinge

Model : 73-1-3520

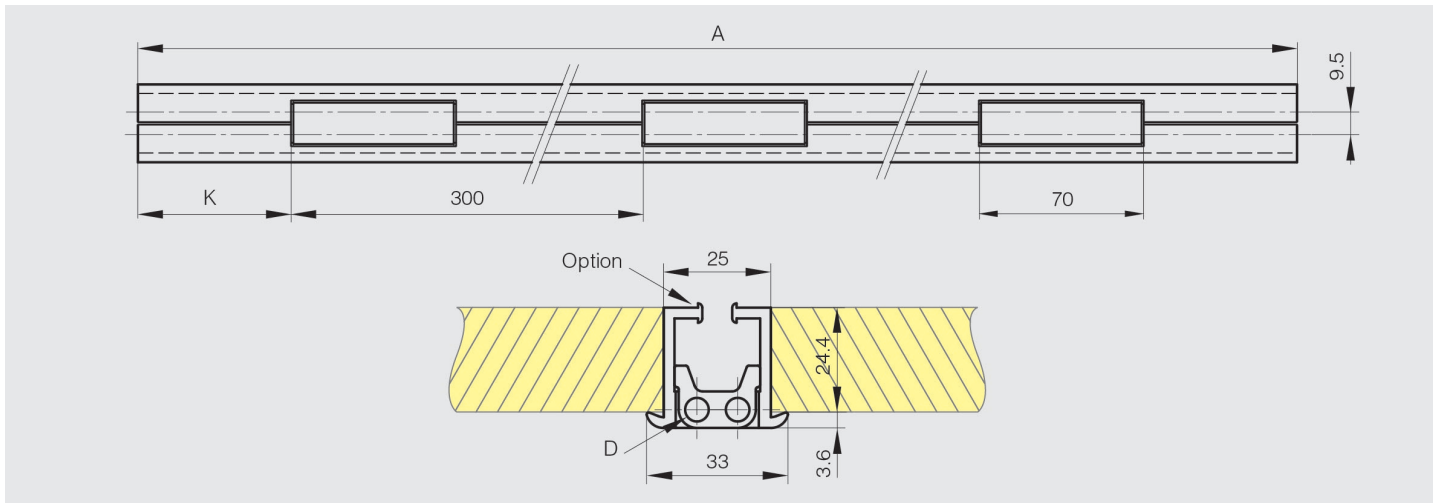

Hinge in aluminium profile for 180° opening angle.
Delivered without watertight gasket (to be ordered separately).
With fixed friction washers.
Non-drilled hinges.



Material	6060 T5 alu
Finish	clear anodised
A (length)	2000
D (pin diameter)	5
Weight (g)	2500
Opening angle	180
K	65
Material	aluminium
Functions	continuous hinges
Pin material	304 stainless steel