

Separation block for GCA-2 central guides

Technopolymer

BODY

Polyethylene based (PE) technopolymer, grey colour.

SCREWS AND NUTS WITH THREAD LOCK

AISI 304 stainless steel.

FEATURES AND APPLICATIONS

PGC-2 separation block is used at the ends of GCA-2 central guides (Fig.1).



Fig.1

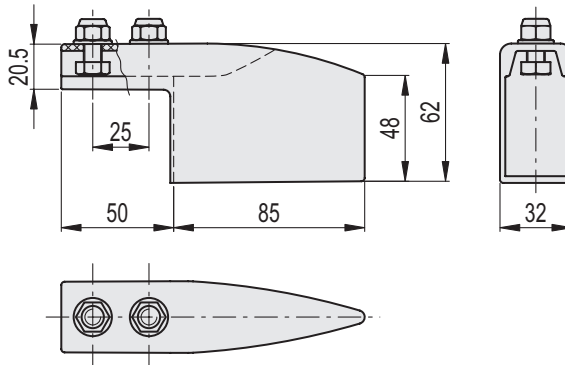
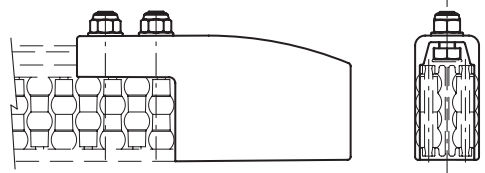
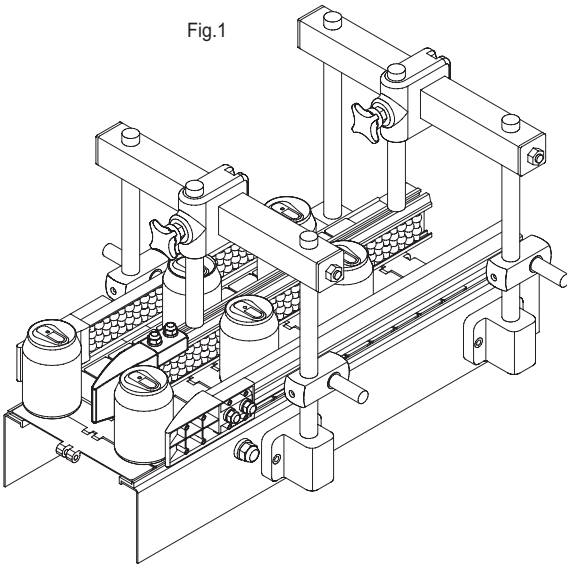

STAINLESS STEEL

Code	Description	
419147	PGC-2-62-135	90