

GN 965

Assembly sets for profile systems 30 / 40

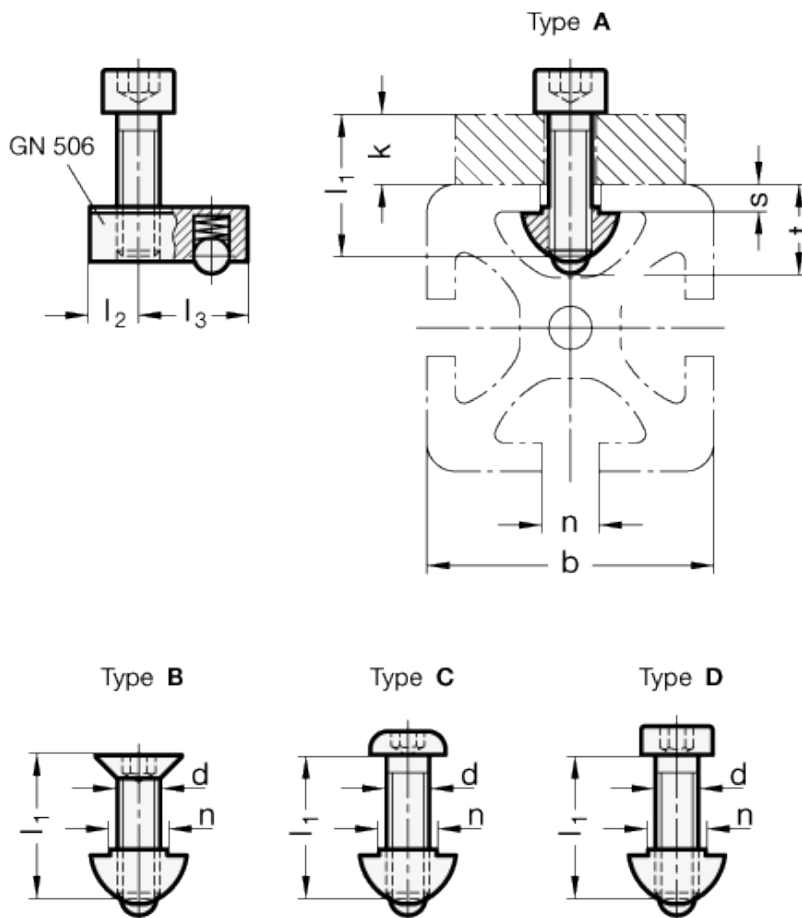

technical informations
T-Nuts GN 506
Zinc-plated Steel, blue passivated.

Ball

Stainless Steel.

Spring

Stainless Steel.

Standard versions available

- Type A: with cylinder head screw DIN 912, zinc plated, blue passivated.
- Type B: with countersunk screw DIN 7991, zinc plated, blue passivated.
- Type C: with lens screw ISO 7380, zinc plated, blue passivated.
- Type D: with cylinder head screw DIN 7984, zinc plated, blue passivated.

Features and applications

Assembly sets GN 965 allow the different standard element to be attached to the most common profile system. Each set includes one T-nut GN 506 and one screw.

Overview to appropriate standards

Assembly sets GN 965 for different ELESA+GANTER standards

<p>Type A Type B Type C Type D</p> 		
<p>Hinges CFA-SL</p>  <p>CFA.65-SL-...</p>	-	GN 965-8-M6-18-A
<p>Hinges CFG.</p>  <p>CFG.30/30 SH-6 CFG.40/40 SH-6</p>	<p>GN 965-6-M6-16-B -</p>	<p>- GN 965-8-M6-18-B</p>
<p>Hinges CFI.</p>  <p>CFI.30-30/30 SH-6 CFI.40-40/40 SH-6</p>	<p>GN 965-6-M6-16-B -</p>	<p>- GN 965-8-M6-18-B</p>
<p>Hinge CFM.</p>  <p>CFM.60-45-SH-6</p>	-	GN 965-8-M6-18-B
<p>Hinges CFMW.</p>  <p>CFMW.70-SH-6 CFMW.100-SH-6</p>	-	GN 965-8-M6-18-B
<p>Hinge CFR.</p>  <p>CFR.60 SH-6</p>	-	GN 965-8-M6-20-B

Hinges with switch CFSQ.



CFSQ.60-SH-6-...

-

GN 965-8-M6-18-B

Hinges with safety switch CFSW.



CFSW.110-6-...

-

GN 965-8-M6-18-B

Bridge handles EBP.



EBP.140-6-...
EBP.140-8-...
EBP.180-8-...
EBP.200-8-...

GN 965-6-M6-16-A

-

-

-

-
GN 965-8-M8-28-A
GN 965-8-M8-28-A
GN 965-8-M8-28-A

Guard safety handles ESP.



ESP.110-SH-...

GN 965-6-M6-18-B

GN 965-8-M6-22-C

Guard wing handles EWP.



EWP.110-SH-...

GN 965-6-M6-18-B

GN 965-8-M6-22-C

Hinges GN 127



GN 127-...-B

-

GN 965-8-M6-20-B

<p>Mounting plate GN 139.3</p> 	GN 139.3-170	GN 965-6-M6-12-A	GN 965-8-M6-14-A
<p>Mounting plate GN 139.4</p> 	GN 139.4-101	GN 965-6-M6-12-A	GN 965-8-M6-14-A
<p>Flanged connector clamps GN 145</p> 	GN 145-...	-	GN 965-8-M5-16-A
<p>Hinges GN 161</p> 	GN 161-57 / 68 / 80	-	GN 965-8-M6-16-B
<p>Base plate connector clamps GN 162.3</p> 	GN 162.3-...	GN 965-6-M5-16-A	GN 965-8-M5-18-A
<p>Tube supports GN 231</p> 	GN 231-B20 / B25 / B30 GN 231-V20 / V25 / V30	- -	GN 965-8-M8-14-A GN 965-8-M8-14-A
<p>Swivel clamp connector bases GN 271</p> 	GN 271-25-...	-	GN 965-8-M5-18-A

Swivel clamp
connector joints GN 281



GN 281-40 / 65

-

GN 965-8-M5-18-A

Tubular handles GN 333



GN 333-28-...-B-...

GN 965-6-M6-25-A

GN 965-8-M6-28-A

Tubular handles GN 333.1



GN 333.1-28-...-B-...

GN 965-6-M6-14-C

GN 965-8-M6-16-C

Oval tubular handles GN 334.1



GN 334.1-36-...

-

GN 965-8-M8-16-C

Mounting blocks GN 412.1



GN 412.1-35-...
GN 412.1-47-...

GN 965-6-M4-16-A
GN 965-6-M5-18-A

-
GN 965-8-M5-20-A

Indexing plungers GN 417



GN 417-5-A / -B / -C
GN 417-6-A / -B / -C
GN 417-8-A / -B
GN 417-8-C

GN 965-6-M4-12-A
GN 965-6-M5-14-A
GN 965-6-M5-14-A
-

-
GN 965-8-M5-16-A
GN 965-8-M5-16-A
GN 965-8-M5-16-A

Foot clamp mountings GN 473



GN 473-B8-...
GN 473-B10 / B12-...
GN 473-B15 / B18-...
GN 473-B20-...

GN 965-6-M4-10-A
-
-
-

GN 965-8-M4-14-A
GN 965-8-M5-12-A
GN 965-8-M6-14-A
GN 965-8-M6-18-A

Clamp mountings GN 477



GN 477-B8-...
GN 477-B10 / B12-...
GN 477-B15 / B16 / B20-...

GN 965-6-M4-16-A
GN 965-6-M5-18-A
GN 965-6-M6-20-A

GN 965-8-M4-20-A
GN 965-8-M5-20-A
GN 965-8-M6-22-A

Flanged bolts GN 480



GN 480-8-...
GN 480-10 / 12-...
GN 480-15 / 16 / 20-...

GN 965-6-M4-10-A
GN 965-6-M5-10-A
GN 965-6-M6-12-A

GN 965-8-M4-12-A
GN 965-8-M5-12-A
GN 965-8-M6-14-A

Cabinet „U“ handles GN 565.1



GN 565.1-20-...
GN 565.1-26-...

GN 965-6-M5-22-A
-

-
GN 965-8-M6-22-A

Cabinet „U“ handles GN 565.2



GN 565.2-26-128-B-...
GN 565.2-26-160-B-...

-
-

GN 965-8-M6-22-C
GN 965-8-M6-22-C

Cam action indexing plungers GN 612.2



GN 612.2-...-16-...
GN 612.2-...-20-...

GN 965-6-M5-18-A
GN 965-6-M5-22-A

GN 965-8-M5-22-A
GN 965-8-M5-25-A







Cam action indexing plungers GN 612.9



GN 612.9-...-16-...
GN 612.9-...-20-...

GN 965-6-M5-18-A
GN 965-6-M5-22-A

GN 965-8-M5-20-A
GN 965-8-M5-25-A

<p>Cam action indexing plungers GN 722.3</p> 	<p>GN 722.3-8-... GN 722.3-10-... GN 722.3-12-... GN 722.3-14-...</p>	<p>- - - -</p>	<p>GN 965-8-M6-18-A GN 965-8-M6-18-A GN 965-8-M6-18-A GN 965-8-M6-18-A</p>
<p>Cabinet „U“ handles GN 728</p> 	<p>GN 728-120-B-... GN 728-180-B-...</p>	<p>GN 965-6-M6-14-A -</p>	<p>- GN 965-8-M8-18-A</p>
<p>Angle pieces / Shackles GN 967</p> 	<p>GN 967-...-20-...-1-... GN 967-...-20-...-2-... GN 967-...-30-...-1-... GN 967-...-30-...-2-... GN 967-...-40-...-1-... GN 967-...-40-...-2-... GN 967-...-45-...-1-... GN 967-...-45-...-2-...</p>	<p>GN 965-6-M5-12-A GN 965-6-M5-12-B GN 965-6-M6-12-A GN 965-6-M6-12-B - - - -</p>	<p>GN 965-8-M5-14-A GN 965-8-M5-14-B GN 965-8-M6-14-A GN 965-8-M6-14-B GN 965-8-M8-16-A GN 965-8-M8-16-B GN 965-8-M8-16-A GN 965-8-M8-16-B</p>
<p>Handles M.443 CH / M. 443 N-CH M.443 AE-V0 / M.443-ESD</p> 	<p>M.443/110-... M.443/140-6-... M.443/140-8-... M.443/150-... M.443/170-... M.443/190-... M.443/196-...</p>	<p>GN 965-6-M6-14-A GN 965-6-M6-16-A - - - - -</p>	<p>GN 965-8-M6-16-A GN 965-8-M6-16-A GN 965-8-M8-18-A GN 965-8-M8-18-A GN 965-8-M8-18-A GN 965-8-M8-20-A GN 965-8-M8-20-A</p>
<p>Tubular handles M.1043</p> 	<p>M.1043/20-...</p>	<p>-</p>	<p>GN 965-8-M8-20-A</p>
<p>Panel support clamp PC</p> 	<p>PC.35</p>	<p>GN 965-6-M6-10-D</p>	<p>GN 965-8-M6-14-D</p>
<p>Angles SQT.</p> 	<p>SQT.40-18-... SQT.40-25-...</p>	<p>- -</p>	<p>GN 965-8-M8-18-C GN 965-8-M8-18-C</p>

Standard Elements	Main dimensions										Weight
	Description	b	n	d	l ₁	k ≈	l ₂	l ₃	s ≈	t ≈	
GN 965-6-M4-10-A	30	6	M 4	10	...	4	5	12	2.9	8.9	6
GN 965-6-M4-12-A	30	6	M 4	12	1 ...	6	5	12	2.9	8.9	7
GN 965-6-M4-16-A	30	6	M 4	16	5 ...	10	5	12	2.9	8.9	7
GN 965-6-M5-10-A	30	6	M 5	10	...	3	5	12	2.9	8.9	6
GN 965-6-M5-12-A	30	6	M5	12	1 ...	5	5	12	2.9	8.9	6
GN 965-6-M5-12-B	30	6	M 5	12	1 ...	5	5	12	2.9	8.9	6
GN 965-6-M5-14-A	30	6	M 5	14	3 ...	7	5	12	2.9	8.9	8
GN 965-6-M5-16-A	30	6	M 5	16	5 ...	9	5	12	2.9	8.9	9
GN 965-6-M5-18-A	30	6	M 5	18	7 ...	11	5	12	2.9	8.9	9
GN 965-6-M5-22-A	30	6	M 5	22	11 ...	15	5	12	2.9	8.9	9
GN 965-6-M6-10-D	30	6	M 6	10	...	3	5	12	2.9	8.9	8

GN 965-6-M6-12-A	30	6	M 6	12	1 ... 4	5	12	2.9	8.9	9
GN 965-6-M6-12-B	30	6	M 6	12	1 ... 4	5	12	2.9	8.9	10
GN 965-6-M6-14-A	30	6	M 6	14	3 ... 6	5	12	2.9	8.9	10
GN 965-6-M6-14-C	30	6	M6	14	3 ... 6	5	12	2.9	8.9	10
GN 965-6-M6-16-A	30	6	M 6	16	5 ... 8	5	12	2.9	8.9	10
GN 965-6-M6-16-B	30	6	M 6	16	5 ... 8	5	12	2.9	8.9	10
GN 965-6-M6-18-B	30	6	M 6	18	7 ... 10	5	12	2.9	8.9	10
GN 965-6-M6-20-A	30	6	M 6	20	9 ... 12	5	12	2.9	8.9	10
GN 965-6-M6-25-A	30	6	M 6	25	14 ... 17	5	12	2.9	8.9	10
GN 965-8-M4-12-A	40	8	M 4	12	... 5	7	15	4.6	11.4	10
GN 965-8-M4-14-A	40	8	M 4	14	1 ... 7	7	15	4.6	11.4	10
GN 965-8-M4-20-A	40	8	M 4	20	7 ... 13	7	15	4.6	11.4	10
GN 965-8-M5-12-A	40	8	M 5	12	... 4	7	15	4.6	11.4	13
GN 965-8-M5-14-A	40	8	M 5	14	1 ... 6	7	15	4.6	11.4	13
GN 965-8-M5-14-B	40	8	M 5	14	1 ... 6	7	15	4.6	11.4	13
GN 965-8-M5-16-A	40	8	M 5	16	3 ... 8	7	15	4.6	11.4	14
GN 965-8-M5-18-A	40	8	M 5	18	5 ... 10	7	15	4.6	11.4	14
GN 965-8-M5-20-A	40	8	M 5	20	7 ... 12	7	15	4.6	11.4	15
GN 965-8-M5-22-A	40	8	M 5	22	9 ... 14	7	15	4.6	11.4	15
GN 965-8-M5-25-A	40	8	M 5	25	12 ... 17	7	15	4.6	11.4	15
GN 965-8-M6-14-A	40	8	M 6	14	1 ... 5	7	15	4.6	11.4	-
GN 965-8-M6-14-B	40	8	M 6	14	1 ... 5	7	15	4.6	11.4	15
GN 965-8-M6-14-D	40	8	M 6	14	1 ... 5	7	15	4.6	11.4	-
GN 965-8-M6-16-A	40	8	M 6	16	3 ... 7	7	15	4.6	11.4	-
GN 965-8-M6-16-B	40	8	M 6	16	3 ... 7	7	15	4.6	11.4	15
GN 965-8-M6-16-C	40	8	M 6	16	3 ... 7	7	15	4.6	11.4	-
GN 965-8-M6-18-A	40	8	M 6	18	5 ... 9	7	15	4.6	11.4	13
GN 965-8-M6-18-B	40	8	M 6	18	5 ... 9	7	15	4.6	11.4	13
GN 965-8-M6-20-B	40	8	M 6	20	7 ... 11	7	15	4.6	11.4	-
GN 965-8-M6-22-A	40	8	M 6	22	9 ... 13	7	15	4.6	11.4	14
GN 965-8-M6-22-C	40	8	M 6	22	9 ... 13	7	15	4.6	11.4	-
GN 965-8-M6-28-A	40	8	M 6	28	15 ... 19	7	15	4.6	11.4	20
GN 965-8-M8-14-A	40	8	M 8	14	1 ... 4	7	15	4.6	11.4	20
GN 965-8-M8-16-A	40	8	M 8	16	3 ... 6	7	15	4.6	11.4	20
GN 965-8-M8-16-B	40	8	M 8	16	3 ... 6	7	15	4.6	11.4	18
GN 965-8-M8-16-C	40	8	M 8	16	3 ... 6	7	15	4.6	11.4	-
GN 965-8-M8-18-A	40	8	M 8	18	5 ... 8	7	15	4.6	11.4	21
GN 965-8-M8-18-C	40	8	M 8	18	5 ... 8	7	15	4.6	11.4	-
GN 965-8-M8-20-A	40	8	M 8	20	7 ... 10	7	15	4.6	11.4	22
GN 965-8-M8-28-A	40	8	M 8	28	15 ... 18	7	15	4.6	11.4	24

