

GN 482

Swivel clamp mountings

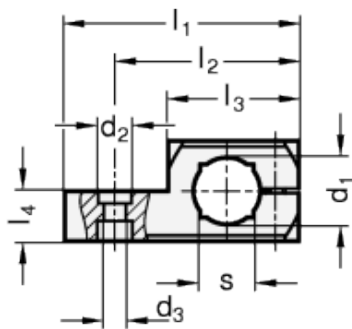

Cylinder head screw
DIN 912

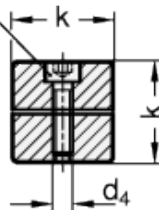

Clamping kit
GN 511

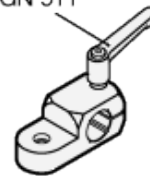

Swivel clamp
mounting joint
with clamping kit
GN 511.1, Type K

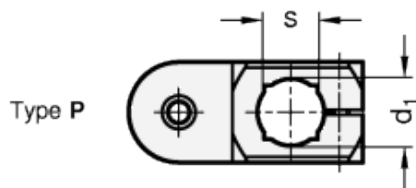
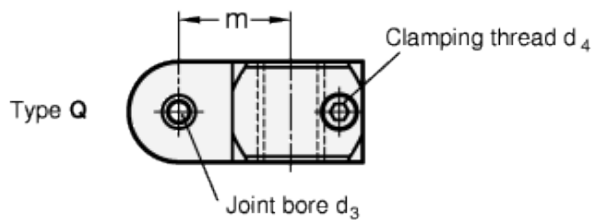
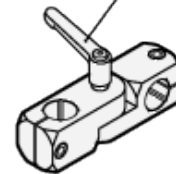

Clamping kit
GN 511.1, Type S

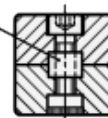

technical informations

Material
Aluminium.

Finish

- Version MT: slided grounded, matte.
- Version ELS: black anodized.

Standard versions available

- Type Q: Clamping bore transverse to the swivel axis.
- Type P: Clamping bore parallel to the swivel axis.

Socket cap screw DIN 912

AISI 304 stainless steel.

Features and applications

Swivel clamp mountings GN 482 can be combined with T-Swivel clamp mountings GN 483 and attachment clamp mountings GN 484 with the same k dimensions into swivel clamp mounting joints. Clamping kits GN 511.1 with screw (type S) and adjustable hand lever (type K) are available for this combination.

Also, the clamping screw $d^{\circ}4^{\circ}$ - which is a cylinder head screw with DIN 912 hexagonal recess in the standard design - can be replaced by a clamping kit GN 511.

The description for ordering is shown in the dimensional table.

Standard Elements	Main dimensions											Clamping kit for d_3	Clamping kit for d_4	Weight g
	Description	d_1	k	d_2	d_3	d_4	l_1	l_2	l_3	m	l_4			
GN 482-B8-16-Q-MT	B8	16	7	4.5	M4	40	32	23	18.5	8	-	GN 511.1-M4-16-S/K	GN 511-M4-16	18
GN 482-B8-16-Q-ELS	B8	16	7	4.5	M4	40	32	23	18.5	8	-	GN 511.1-M4-16-S/K	GN 511-M4-16	19
GN 482-B10-20-Q-MT	B10	20	8.5	5.5	M5	50	40	29	23	10	8	GN 511.1-M5-20-S/K	GN 511-M5-20	35
GN 482-B10-20-Q-ELS	B10	20	8.5	5.5	M5	50	40	29	23	10	8	GN 511.1-M5-20-S/K	GN 511-M5-20	36
GN 482-B12-20-Q-MT	B12	20	8.5	5.5	M5	50	40	29	23	10	10	GN 511.1-M5-20-S/K	GN 511-M5-20	45
GN 482-B12-20-Q-ELS	B12	20	8.5	5.5	M5	50	40	29	23	10	10	GN 511.1-M5-20-S/K	GN 511-M5-20	46
GN 482-B15-25-Q-MT	B15	25	10	6.5	M6	62	49.5	36	29	12.5	12	GN 511.1-M6-25-S/K	GN 511-M6-25	65
GN 482-B15-25-Q-ELS	B15	25	10	6.5	M6	62	49.5	36	29	12.5	12	GN 511.1-M6-25-S/K	GN 511-M6-25	66
GN 482-B16-25-Q-MT	B16	25	10	6.5	M6	62	49.5	36	29	12.5	-	GN 511.1-M6-25-S/K	GN 511-M5-25	68
GN 482-B16-25-Q-ELS	B16	25	10	6.5	M6	62	49.5	36	29	12.5	-	GN 511.1-M6-25-S/K	GN 511-M5-25	69
GN 482-B20-30-Q-MT	B20	30	10	6.5	M6	70	55	39	33.5	15	16	GN 511.1-M6-30-S/K	GN 511-M6-30	100
GN 482-B20-30-Q-ELS	B20	30	10	6.5	M6	70	55	39	33.5	15	16	GN 511.1-M6-30-S/K	GN 511-M6-30	101
GN 482-B8-16-P-MT	B8	16	7	4.5	M4	40	32	23	18.5	8	-	GN 511.1-M4-16-S/K	GN 511-M4-16	18
GN 482-B8-16-P-ELS	B8	16	7	4.5	M4	40	32	23	18.5	8	-	GN 511.1-M4-16-S/K	GN 511-M4-16	19
GN 482-B10-20-P-MT	B10	20	8.5	5.5	M5	50	40	29	23	10	8	GN 511.1-M5-20-S/K	GN 511-M5-20	36
GN 482-B10-20-P-ELS	B10	20	8.5	5.5	M5	50	40	29	23	10	8	GN 511.1-M5-20-S/K	GN 511-M5-20	37
GN 482-B12-20-P-MT	B12	20	8.5	5.5	M5	50	40	29	23	10	10	GN 511.1-M5-20-S/K	GN 511-M5-20	45
GN 482-B12-20-P-ELS	B12	20	8.5	5.5	M5	50	40	29	23	10	10	GN 511.1-M5-20-S/K	GN 511-M5-20	46
GN 482-B15-25-P-MT	B15	25	10	6.5	M6	62	49.5	36	29	12.5	12	GN 511.1-M6-25-S/K	GN 511-M6-25	65
GN 482-B15-25-P-ELS	B15	25	10	6.5	M6	62	49.5	36	29	12.5	12	GN 511.1-M6-25-S/K	GN 511-M6-25	66
GN 482-B16-25-P-MT	B16	25	10	6.5	M6	62	49.5	36	29	12.5	-	GN 511.1-M6-25-S/K	GN 511-M5-25	70
GN 482-B16-25-P-ELS	B16	25	10	6.5	M6	62	49.5	36	29	12.5	-	GN 511.1-M6-25-S/K	GN 511-M5-25	71
GN 482-B20-30-P-MT	B20	30	10	6.5	M6	70	55	39	33.5	15	16	GN 511.1-M6-30-S/K	GN 511-M6-30	100
GN 482-B20-30-P-ELS	B20	30	10	6.5	M6	70	55	39	33.5	15	16	GN 511.1-M6-30-S/K	GN 511-M6-30	101

