

## Articulated side guides

### Technopolymer, stainless steel

#### BODY

Acetal resin based (POM) technopolymer, black colour.

#### PINS

AISI 304 stainless steel.

#### ROLLERS

Polyethylene based (PE) technopolymer, grey colour.

#### STANDARD EXECUTIONS

- **GLB-2-RS**: with spherical contact rollers.
- **GLB-2-RC**: with cylindrical contact rollers.
- **GLB-2-RT**: with round contact rollers.

#### FEATURES AND APPLICATIONS

GLB-2 side guides are modular self-supporting structures for the side guide of products with important vertical dimensions on conveyor belts (Fig.1).

Particularly suitable for use in wet environments.

Depending on the product to transport, it is recommended to use:

- GLB-2-RS: for the guide of products in cans or in plastic containers;
- GLB-2-RC: for the guide of cardboard products, for a greater fluency;
- GLB-2-RT: for the guide of glass products, in case of accidental breakage they facilitate the expulsion of debris.

The joint in the roller side guides allows an external curvature radius 500 mm, internal curvature radius 350 mm.

Supplied already assembled in modules of 375 mm length, for profiles 40x8 mm.

#### SPECIAL EXECUTIONS ON REQUEST

- Side guides with body and rollers in different colours.
- Side guides with pins in acetal resin based (POM) technopolymer.

#### ACCESSORIES ON REQUEST

- PRA-GLB: AISI 304 stainless steel profile for side guides.
- PRB-GLB: AISI 304 stainless steel profile for side guides.

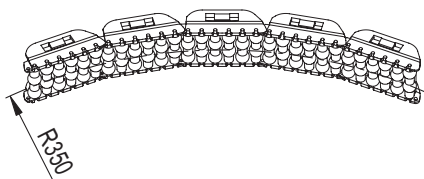
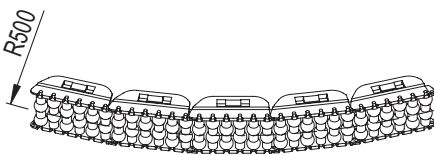
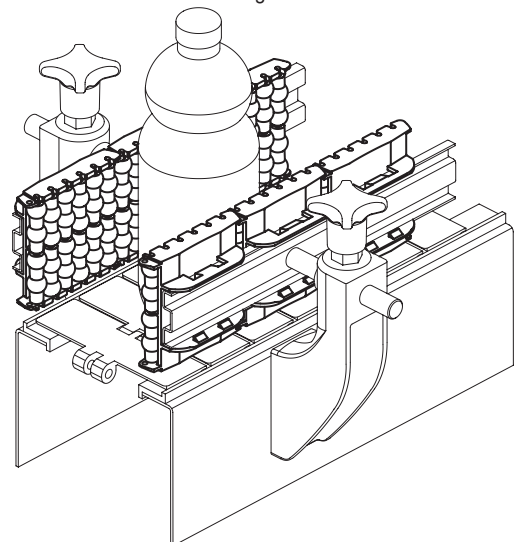
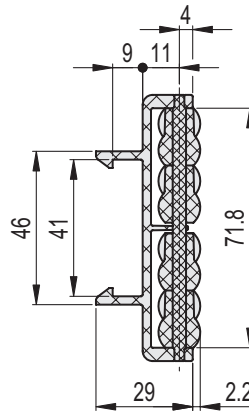
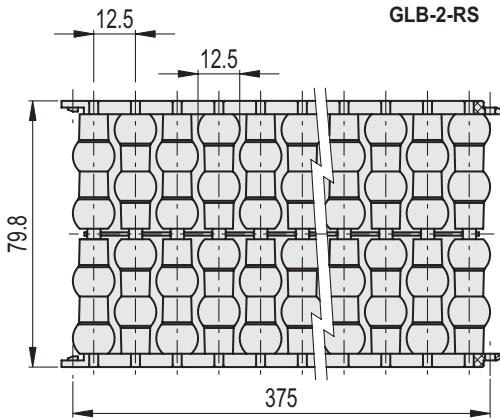

Fig.1





**GLB-2-RS** **STAINLESS STEEL**

Code	Description	⚖️
419171	GLB-2-RS-80-375	690

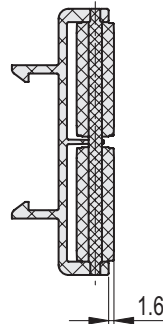
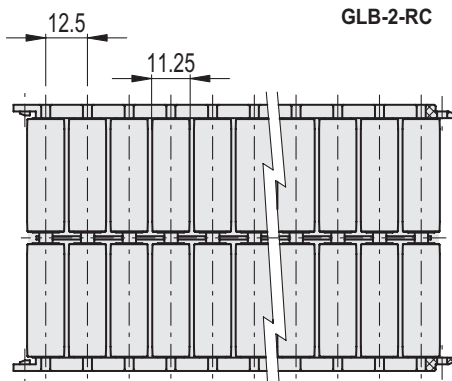

**GLB-2-RC** **STAINLESS STEEL**

Code	Description	⚖️
419172	GLB-2-RC-80-375	690

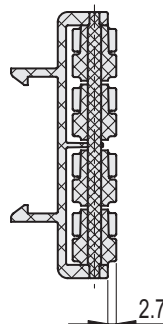
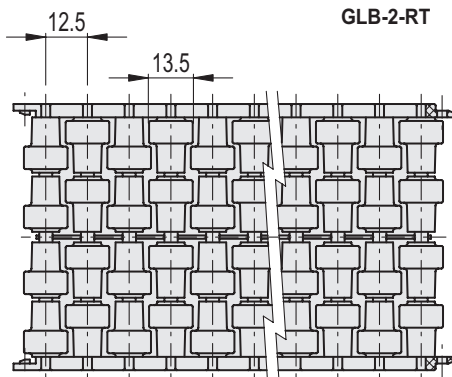

**GLB-2-RT** **STAINLESS STEEL**

Code	Description	⚖️
419173	GLB-2-RT-80-375	690



11  
Levelling elements