

## Handles with monostable electrical switch and LED indicator light

### Self-extinguishing technopolymer

#### MATERIAL

- **Handle body:** glass-fibre reinforced polyamide based (PA) technopolymer certified self-extinguishing UL-94 V0, black colour, matte finish.
- **LED light diffuser:** self-extinguishing polycarbonate UL-94 V0, opal colour.
- **Button cover:** polyamide-based (PA) technopolymer, black colour.

#### MICROSWITCH WITH BUTTON

With two slow action electrical contacts with double interruption Zb shaped (see IEC EN 60947-5-1) which can be set in normally open (NO) or normally closed (NC) mode in production.

Positive opening in compliance with IEC EN 60947-5-1 annex K: the separation of the electrical contacts is the direct result of an actuator action on which an action force is applied by means of non elastic elements, that is to say not dependant on, for example, spring-like elements.

The contact elements guarantee a self-cleaning action of the silver pastes.

#### LED STRIP

Type RGY, supply voltage 24Vdc +/- 10%. Colour tones may vary slightly depending on the power supply voltage.

#### STANDARD EXECUTIONS

- Brass bushings, M6 threaded blind holes for rear mounting.
- **M.2000-SWM-C:** zinc-plated connector with 8 poles, back output.
- **M.2000-SWM-F2.5:** 8 pole cable, length 2,5 metres, back output.
- **M.2000-SWM-F5:** 8 pole cable, length 5 metres, back output.

#### CONTACT BLOCKS IN THE STANDARD EXECUTION:

- 2NC: 2 NC contacts.
- NC + NO: 1 NC contact + 1 NO contact.

#### IP PROTECTION

IP67 protection class, see Table EN 60529.

#### FEATURES AND APPLICATIONS

The M.2000-SWM handle is an ideal combination of ergonomics, functionality, and compactness.

In addition to the handle function, it integrates in a single product the function of signalling light column and control box with normally open or normally closed contacts. These handles are typically assembled on machine doors or protections. With the appropriate electrical connection, it is possible to configure the colour of the LED strip to indicate the status of the guard.

Example:

- red: machinery in operation, no access.
- green: possible access under safe conditions.
- yellow: wait, machinery shutting down.

By pressing the button, the operator requires access to the protected area through external logic.

Staff protection: The positive action NC (normally closed) switch ensures correct interruption of the power supply circuit.

In case of use of an extension with angled connector, the direction of the cable output is shown in Fig.1.

#### TECHNICAL DATA

Tensile stress and impact strength: the values F1, F2, L1 and L2 indicated in the table were obtained during breaking tests carried out under the test conditions shown in the figure with ambient temperature.



ELESA Original design



#### ACCESSORIES ON REQUEST

FC-M12x1 (see page -): extensions with 8 pole M12 female axial connector.

#### SPECIAL EXECUTIONS ON REQUEST

- 2 NO contacts.
- LED operating voltage 12V.
- Quick release electrical contact.

#### ANOTHER STANDARD EXECUTION

M.2000: single complementary handle without switch.

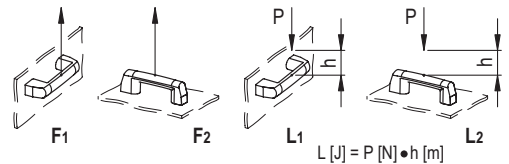

M.2000-C

M.2000-F

Fig.1

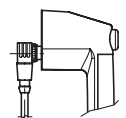
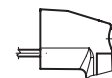
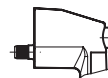

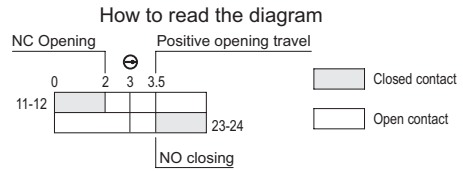
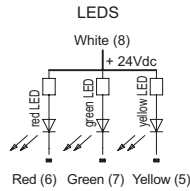
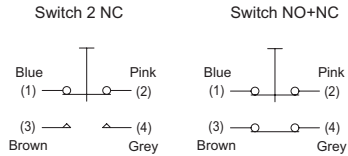
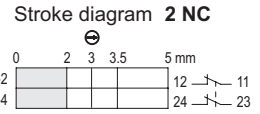
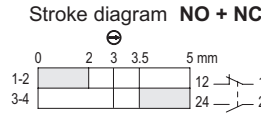
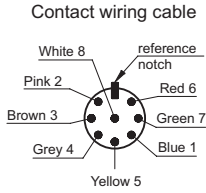

Mechanical features	Electrical features	
<b>Type of contacts:</b> Ag 999	<b>Thermic power I<sub>th</sub></b>	Cable 4 A Connector 2.5 A
<b>Maximum operating frequency:</b> 3600 cycles/hour *	<b>Insulation nominal UI voltage</b>	Cable: 250 Vac Connector: 30 Vac/Vdc
<b>Mechanical life-span</b> (test mode according to standard IEC 60947-5-1): 10 million	<b>Short circuit protection:</b> 4A 500V gG	<b>Resistance between contacts:</b> 25 mΩ
<b>Cable bending radius</b> > 70 mm	<b>Category of use (cable)</b>	
	le/AC-15 (according to IEC 60945-5-1)	24V-50/60 Hz      4A 240V-50/60 Hz      3A
	le/DC-13 (according to IEC 60947-5-1)	24V-d.c.      2A 240V-d.c.      0.4A
	<b>Category of use (connector)</b>	
	le/DC-13 (according to IEC 60947-5-1)	24V-d.c.      2A
	<b>B10D:</b> 20 million manoeuvres	<b>Pollution degree:</b> 3

\* according to standard EN 60947-5-1

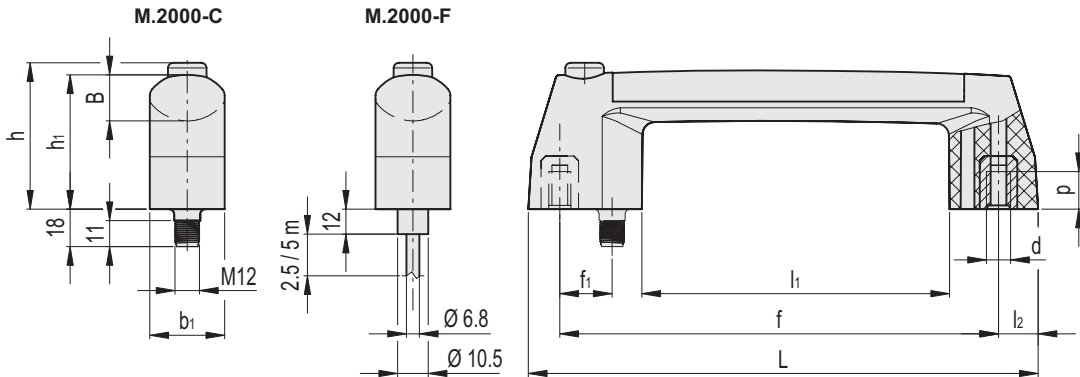

### M.2000-SWM-C

Code	Description	L	fz1	d	f1	h	h1	B	b1	l1	l2	p	F1 [N]	F2 [N]	L1 [J]	L2 [J]	△
260801-C1	M.2000/180-SWM-1NC+1NO-RGY-C	212.5	180	M6	29	70	65	24	35	113	20	12	700	900	7	6	256
260802-C1	M.2000/180-SWM-2NC-RGY-C	212.5	180	M6	29	70	65	24	35	113	20	12	700	900	7	6	256

### M.2000-SWM-F2.5

Code	Description	L	fz1	d	f1	h	h1	B	b1	l1	l2	p	F1 [N]	F2 [N]	L1 [J]	L2 [J]	△
260811-C1	M.2000/180-SWM-1NC+1NO-RGY-F2.5	212.5	180	M6	29	70	65	24	35	113	20	12	700	900	7	6	410
260812-C1	M.2000/180-SWM-2NC-RGY-F2.5	212.5	180	M6	29	70	65	24	35	113	20	12	700	900	7	6	410

### M.2000-SWM-F5

Code	Description	L	fz1	d	f1	h	h1	B	b1	l1	l2	p	F1 [N]	F2 [N]	L1 [J]	L2 [J]	△
260821-C1	M.2000/180-SWM-1NC+1NO-RGY-F5	212.5	180	M6	29	70	65	24	35	113	20	12	700	900	7	6	560
260822-C1	M.2000/180-SWM-2NC-RGY-F5	212.5	180	M6	29	70	65	24	35	113	20	12	700	900	7	6	560